

S I G N S



“ **Questione di segni.** ”
Issues of signs.

Cosa propone CD Signs: **What's on the CD Signs:**

CD Signs è un programma completo di elementi studiati per trasmettere indicazioni e/o informazioni in locali interni e spazi esterni.

Questo nuovo sistema di segnaletica consente molteplici soluzioni, sempre create in modo intuitivo, abbinando la vasta gamma di finiture con le moderne tecniche di decorazione e le misure personalizzabili: il tutto favorito dagli alti standard qualitativi dei componenti.

CD Signs is a complete program of elements designed to convey indication and/or information in internal and external spaces.

This new system of signposting allows multiple solutions, always intuitively created, combining a wide range of finishes with modern decoration techniques and customizable measures: all helped by the high quality standards components.





01 CUSTOMIZZAZIONE SOFT CUSTOM

Grazie alle innovative tecniche di decorazione dei pannelli, CD SIGNS garantisce risultati di alta qualità e di eccezionale durata.

E' possibile scegliere qualsiasi combinazione di colori PANTONE per sfondo e icone: infinite combinazioni per adattarsi a ogni tipo di spazio e progetto.

Grazie alla tecnologia della stampa diretta è inoltre possibile, tramite il servizio custom made, ottenere decorazioni personalizzate.

Thanks to the innovative techniques of the panels decoration, CD SIGNS guarantees high quality and exceptional durability.

You can choose any combination of PANTONE colors for background and icons: infinite combinations to fit your space and your project.

Thanks to the direct printing technology is also possible, a tailor made service, getting personalized decoration in photo quality.







02

TIPOLOGIE DI FISSAGGIO FIXING TYPOLOGIES

I pannelli di segnalazione possono essere fissati direttamente tramite fissaggio biadesivo 3M, o tramite i kit di fissaggio CD SIGNS: realizzati in ottone, consentono una semplice e rapida installazione.

E' possibile installare a muro i pannelli in modo parallelo, perpendicolare, oppure a sospensione dal soffitto.

Le finiture disponibili comprendono una vasta gamma di colori.







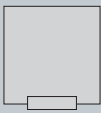

Tutti i supporti offrono alloggiamenti del pannello regolabili per offrire la massima flessibilità su spessori e materiali personalizzati a seconda delle esigenze architettoniche.

Signs panels can be fixed directly using 3M double sided tape, or using the CD SIGNS kits: made in brass, allow a simple and rapid installation.

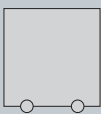
It is possible to install the panels in parallel and perpendicular to the wall, or hanging from the ceiling.

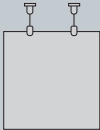
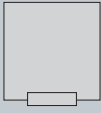
Finishes include a wide range of colors.

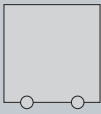
All CD SIGNS kits are adjustable for maximum flexibility and to comply with the customer's needs.

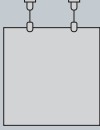
	supporti paralleli parallel clamps	supporti 90° 90° clamps	supporti a soffitto hanging clamps
7 mm			
			
3 mm			
			







03

DETTAGLI DI QUALITA' QUALITY DETAILS

CD SIGNS offre al settore della segnaletica gli elevati standard di design e qualità tipici di Colombo Design.

Le finiture galvaniche si abbinano secondo le esigenze del cliente alle targhe in acciaio inox satinato ad alto spessore o in perspex lucido ultra-clear.

Supporti e kit di fissaggio coordinati garantiscono quindi ad ogni progetto le migliori performance tecniche e di durata offrendo al tempo stesso coerenza visiva ed eleganza formale.

La flessibilità del sistema di decorazione offre inoltre la possibilità di abbinamenti cromatici perfetti.

CD SIGNS offers the high standards of design and quality of Colombo Design.

Galvanic finishes are combined according to the customer's requirements to the thick satin stainless steel plates or to the glossy ultra perspex-clear ones.

Supports and fastening kits are coordinated to guarantee to every project the best technical performance and durability offering at the same time visual consistency and formal elegance.

The flexibility of the system of decoration also offers to each customer the possibility of having perfect color combinations.

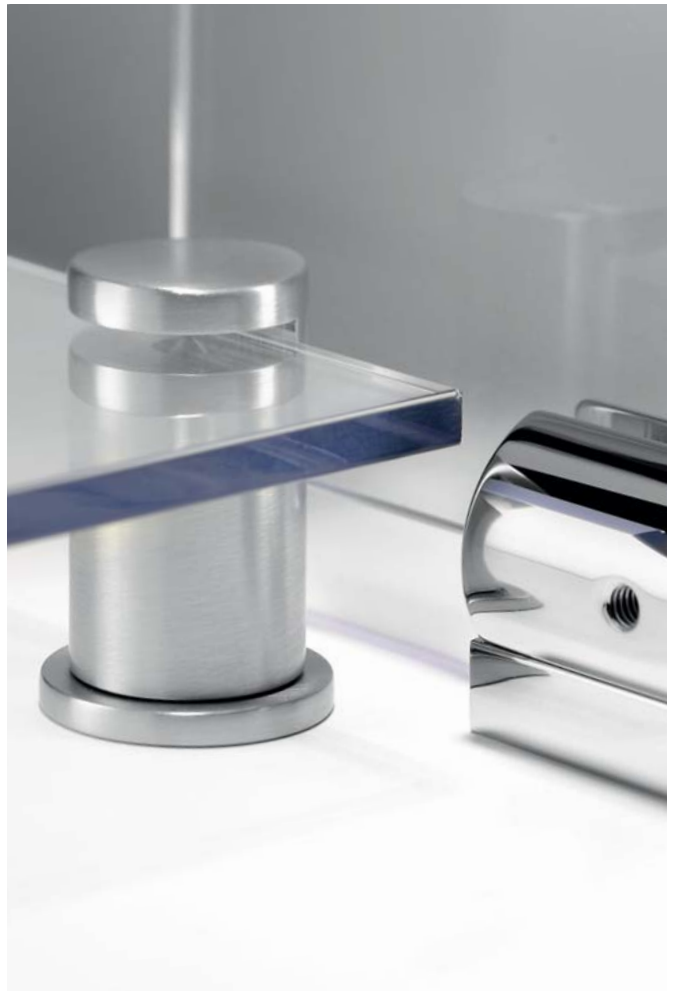



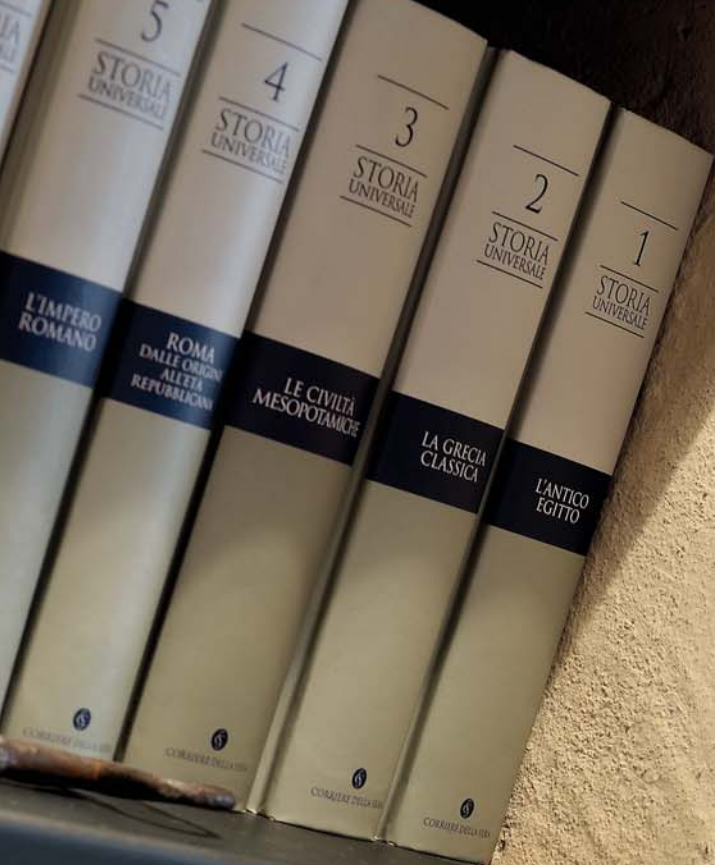





A
A
96/2003)

Settembre, 1
Tel. 035-217301

04 PERSONALIZZAZIONE CUSTOM MADE

CD SIGNS offre un servizio di personalizzazione estremamente flessibile: è possibile gestire grandi o piccoli progetti di comunicazione segnaletica decidendo formati, materiali, colori, tecniche di decorazione e sistemi di fissaggio.

Combinazioni e soluzioni virtualmente illimitate a disposizione di architetti, aziende ed esercizi commerciali interessati a portare il proprio progetto o la propria immagine coordinata ad un livello superiore.

Richiedi un contatto diretto per conoscere le opportunità più adatte alle tue esigenze.

CD SIGNS offers flexible personalization: you can handle large or small projects of communication by deciding formats, materials, colors, techniques of decoration and fastening systems.

Unlimited practicable combinations and solutions are available for architects, corporations or businesses interested in bring their own project or their corporate image to a higher level.

Request a direct contact to get to know the opportunities best suited to your needs.

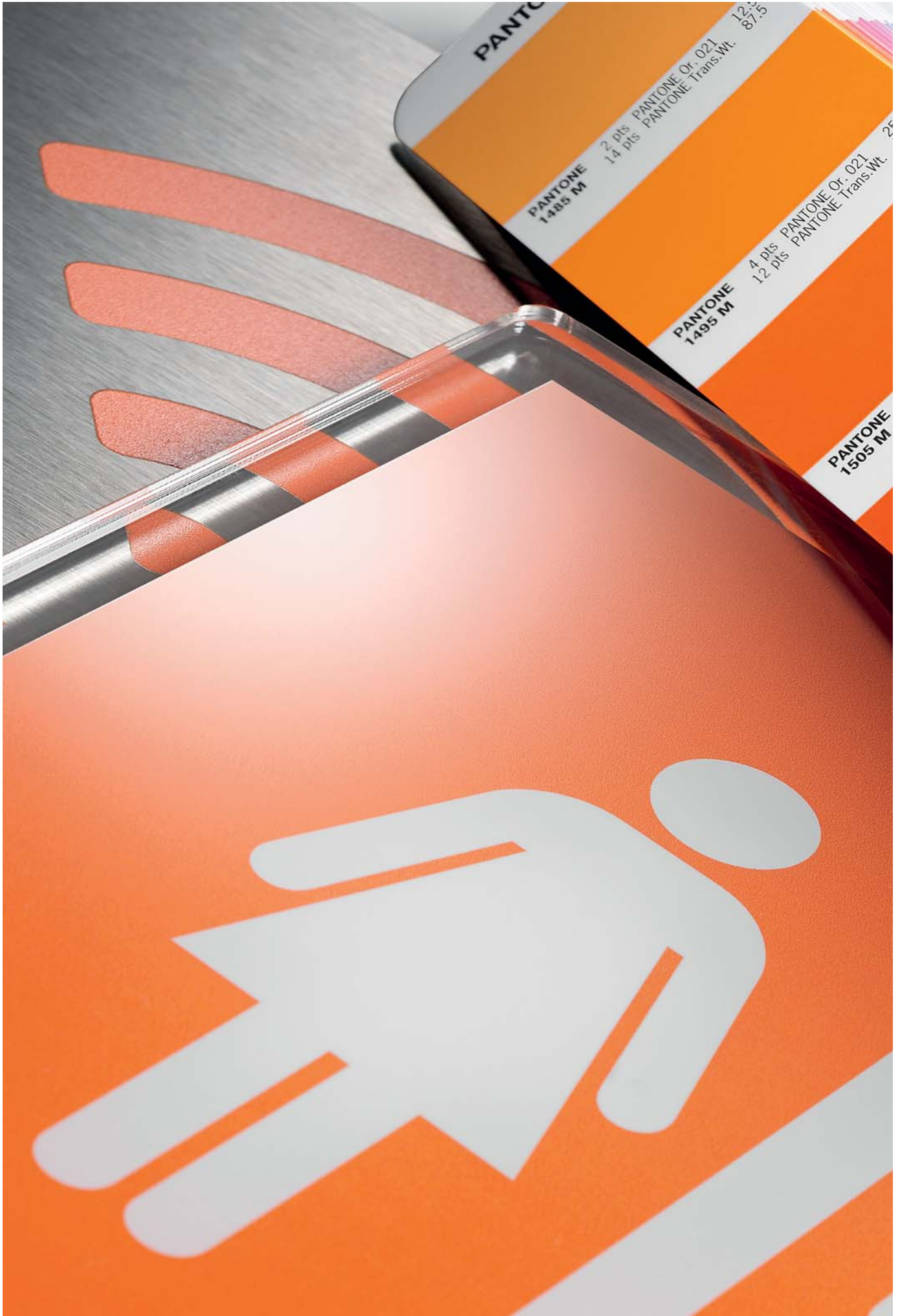



» VIVERE LA MUSICA
» ESPLORARLA » SCOPRIRLA



BANG & OLUFSEN



QUESTO NEGOZIO È SOTTOPOSTO A
VIDEOSORVEGLIANZA CONTINUA

BANG & OLUFSEN



WiFi



05 DATI TECNICI TECHNICAL DATAS

Combinazioni standard disponibili per targhe e sistemi di fissaggio.

Per ogni altra esigenza è disponibile il servizio custom made.

Standard combinations are available.

For any other needs tailor made service is available, please contact us.

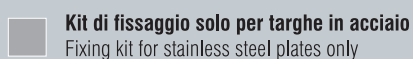



* **Targa ACCIAIO**
Stainless steel plates

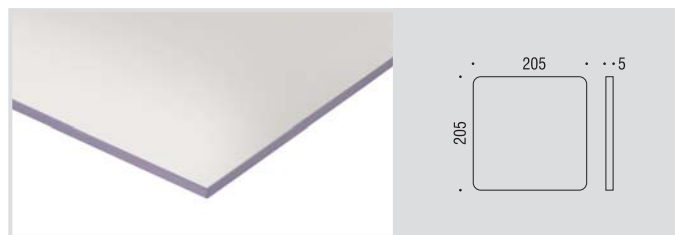

* **Targa PLEXIGLASS**
Plexiglass plates

Codice da comporre seguendo le istruzioni a pag. 24-25
* Article code formulated as per the instructions on page 24-25.

Kit di fissaggio

Fixing kit

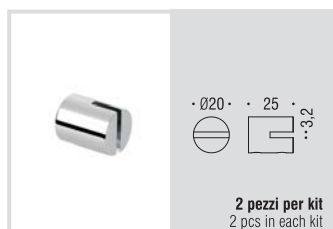

TKIT/01
Ferma pannelli a bandiera per spessore max 3mm
Flag-type kit for thickness max 3mm

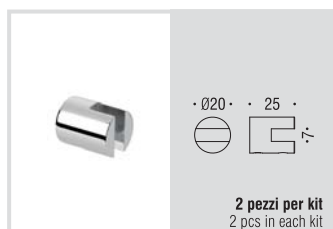

TKIT/02
Ferma pannelli a bandiera per spessore max 7mm
Flag-type kit for thickness max 7mm

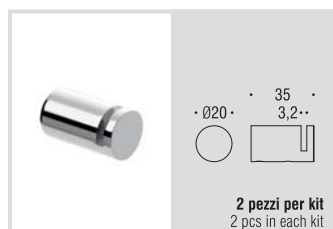

TKIT/03
Ferma pannelli frontale per spessore max 3mm
Front-type kit for thickness max 3mm

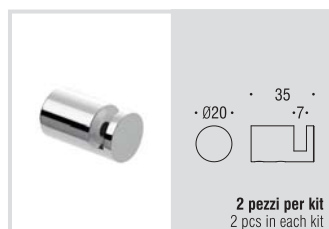

TKIT/04
Ferma pannelli frontale per spessore max 7mm
Front-type kit for thickness max 7mm

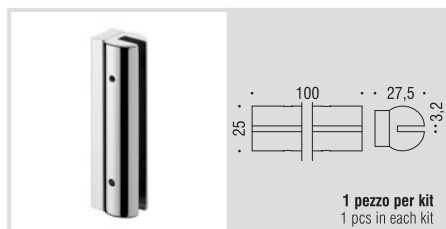

TKIT/05 B
Barra reggi pannelli a bandiera per spessore 3mm
Flag-type kit for thickness 7mm

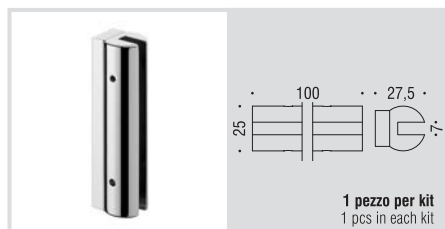

TKIT/05
Barra reggi pannelli a bandiera per spessore 7mm
Flag-type kit for thickness 7mm

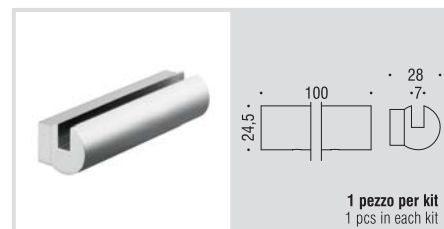

TKIT/06
Barra reggi pannelli frontale per spessore 3-7mm
Front-type kit for thickness 3-7mm

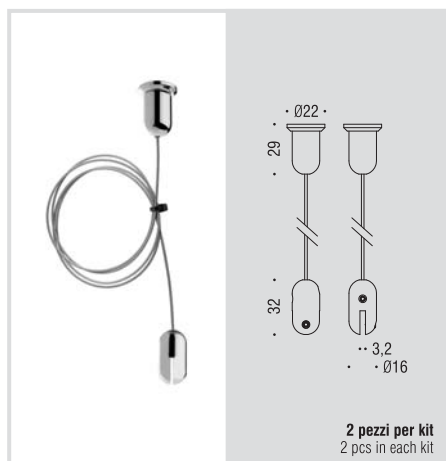

TKIT/07
Kit per pannelli sospesi per spessore max 3 mm.
Lunghezza cavo regolabile max 1 mt
Kit for hanging signs for thickness 3mm.
Cable length adjustable max 1mt

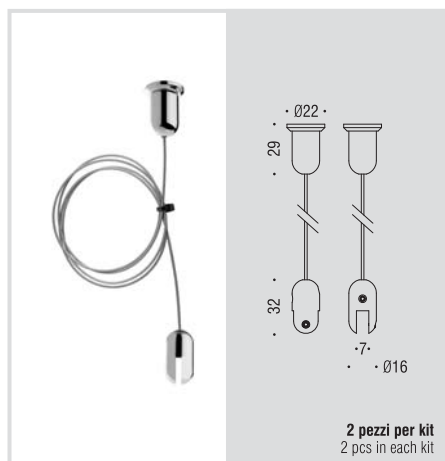

TKIT/08
Kit per pannelli sospesi per spessore max 7mm.
Lunghezza cavo regolabile max 1 mt
Kit for hanging signs for thickness 7mm.
Cable length adjustable max 1mt



TKIT/09
Kit per fissaggio ad incollo. Biadesivo 3M
3M adhesive double sided fixing kit.

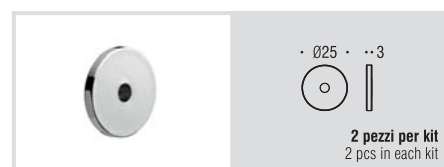

TKIT/10
Kit fissaggio per superfici irregolari. Rondella Ø25.
Abbinabile solo per TKIT/01, TKIT/02, TKIT/03 e TKIT/04
Fixing kit for irregular surfaces. Washer Ø25.
Suitable only for TKIT/01, TKIT/02, TKIT/03 and TKIT/04

INFORMAZIONI UTILI IN FASE D'ORDINE

USEFUL INFORMATIONS WHEN ORDERING

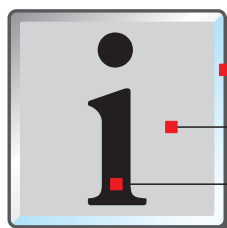

materiale standard
standard material

colore pantone sfondo
pantone background color

colore pantone icona
pantone icon color

Esempio: per ordinare la **targa** sopra riportata formulare il codice di acquisto come segue (fare riferimento alle tabelle della pagina accanto):
Example: to order the above plate formulate the article code as follows (refer to the table on the next page):

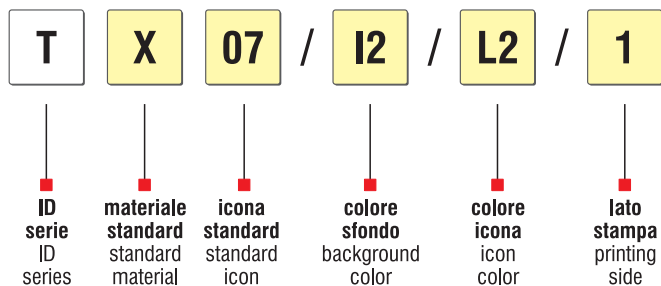

AVVERTENZE

IMPORTANT NOTES

i I colori dello sfondo (grigio) ed icona (nero) delle **ICONE STANDARD** e solo quelli, possono essere modificati secondo la tabella pantone a fianco riportata.
Only the colors of the background (grey) and icon (black) of the standard icons, can be modified according to the pantone table.

i Oltre alla **gamma colori standard** è possibile indicare le tinte desiderate per sfondo e icone tramite codice **PANTONE**.
In addition to the standard range of colors you can indicate the desired colors for background and icons using pantone code.

i Le nostre targhe **standard** hanno una dimensione che consente una visibilità fino a 8,5m.
Our standard plates should be placed no more than 8,5 m field of vision.

i E' possibile realizzare **ICONE PERSONALIZZATE**.
It is possible to make custom icons.

i I kit di fissaggio (eccetto TKIT/09 e TKIT/10) prevedono bussole e brugole di montaggio. **Viti e tasselli esclusi**.
The packages (except for TKIT/09 and TKIT/10) include threaded bush, grubscrews and allen key. Screws and nylon fishers are not included.

Per realizzazioni **CUSTOM MADE** quali totem, insegne luminose, pannelli indicativi, targhe fuori misura chiamare il numero **035.49.49.001** o inviare una mail di richiesta all'indirizzo **info@colombodesign.it**
i For custom made products such as totem, illuminated signs, identification plates, oversized plates, call 035.49.49.001 or send an email at info@colombodesign.it

i Per una durata ottimale del prodotto: evitare l'impiego di solventi, abrasivi, alcool e rimuovere lo sporco e la polvere solo con panno inumidito in acqua fredda.
For maximum durability: do not use solvents, abrasives or alcohol, remove dirt and dust only with a cloth dampened in water.

i Le texture ed i colori dei materiali e delle finiture hanno valore indicativo in quanto soggetti alle tolleranze dei processi di stampa.
The textures and colors of materials and finishes are not binding as they depend on printing color tolerances.

i Le misure sono espresse in millimetri.
Sizes are in millimeters.

i Colombo Design si riserva di apportare ai propri prodotti ogni modifica estetica e tecnica che a suo insindacabile giudizio ritenga necessaria.
Colombo Design reserves the right to modify parts of its collection range whenever necessary without previous notice to the customer.

i Il presente catalogo è tutelato dalla legge sui diritti di autore di esso è quindi proibita ogni riproduzione, totale o anche parziale.
This catalogue is protected by the Italian copyright law and all rights are reserved. No part of this price list may be reproduced in any form or by any means.

MATERIALE STANDARD
STANDARD MATERIAL

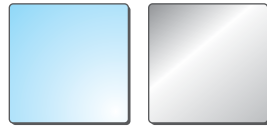

P plexiglass
X inox AISI 304 satin stainless steel

LATI STAMPA
PRINTING SIDES

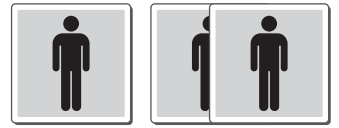

1 fronte one sided
2 fronte/retro double sided

ICONE STANDARD
STANDARD ICONS



COLORI PANTONE ICONE E SFONDI
PANTONE COLOR FOR ICONS AND BACKGROUND

	0	1	2	3	4	5	6	7	8	9
A	100 C	102 C	Yellow C	109 C	113 C	122 C	124 C	130 C	137 C	143 C
B	148 C	150 C	152 C	Orange 021 C	158 C	471 C	478 C	492 C	483 C	476 C
C	176 C	1765 C	1785 C	191 C	192 C	193 C	194 C	485 C	195 C	229 C
D	263 C	243 C	245 C	247 C	255 C	2582 C	2725 C	2718 C	2728 C	2748 C
E	290 C	2915 C	2925 C	293 C	2945 C	302 C	534 C	303 C	7463 C	539 C
F	317 C	318 C	319 C	320 C	322 C	340 C	341 C	355 C	3415 C	3308 C
G	365 C	366 C	367 C	376C	377 C	384 C	385 C	445 C	447 C	448 C
H	Warm Grey 1 C 1	Warm Grey 2 C	Warm Grey 4 C	Warm Grey 5 C	Warm Grey 6 C	Warm Grey 7 C	Warm Grey 8 C	Warm Grey 9 C	Warm Grey 11 C	Black 7 C
I	5% Black	10% Black	20% Black	30% Black	40% Black	50% Black	60% Black	70% Black	80% Black	90% Black
L	Neutro Neutral	White	100% Black	Wood 1	Wood 2	Wood 3	Wood 4	Wood 5	Wood 6	Wood 7



COLOMBO DESIGN S.p.A.
Via Baccanello, 22
24030 Terno d'Isola (BG) Italia
☎ 035.49.49.001
Fax 035.90.54.44
Export Office
☎ (+39) 035.90.54.75
Fax (+39) 035.49.40.257

Internet: <http://www.colombodesign.it>
e-mail: info@colombodesign.it

